

# PROJEKT TRŽNICE

---



**REKONSTRUKCIJA PARTERA  
OTVORENOG  
DIJELA TRŽNICE**

**NATKRIVANJE  
OTVORENOG DIJELA  
TRŽNICE**

**STVARANJE NOVOG  
VIZUALNOG IDENTITETA**



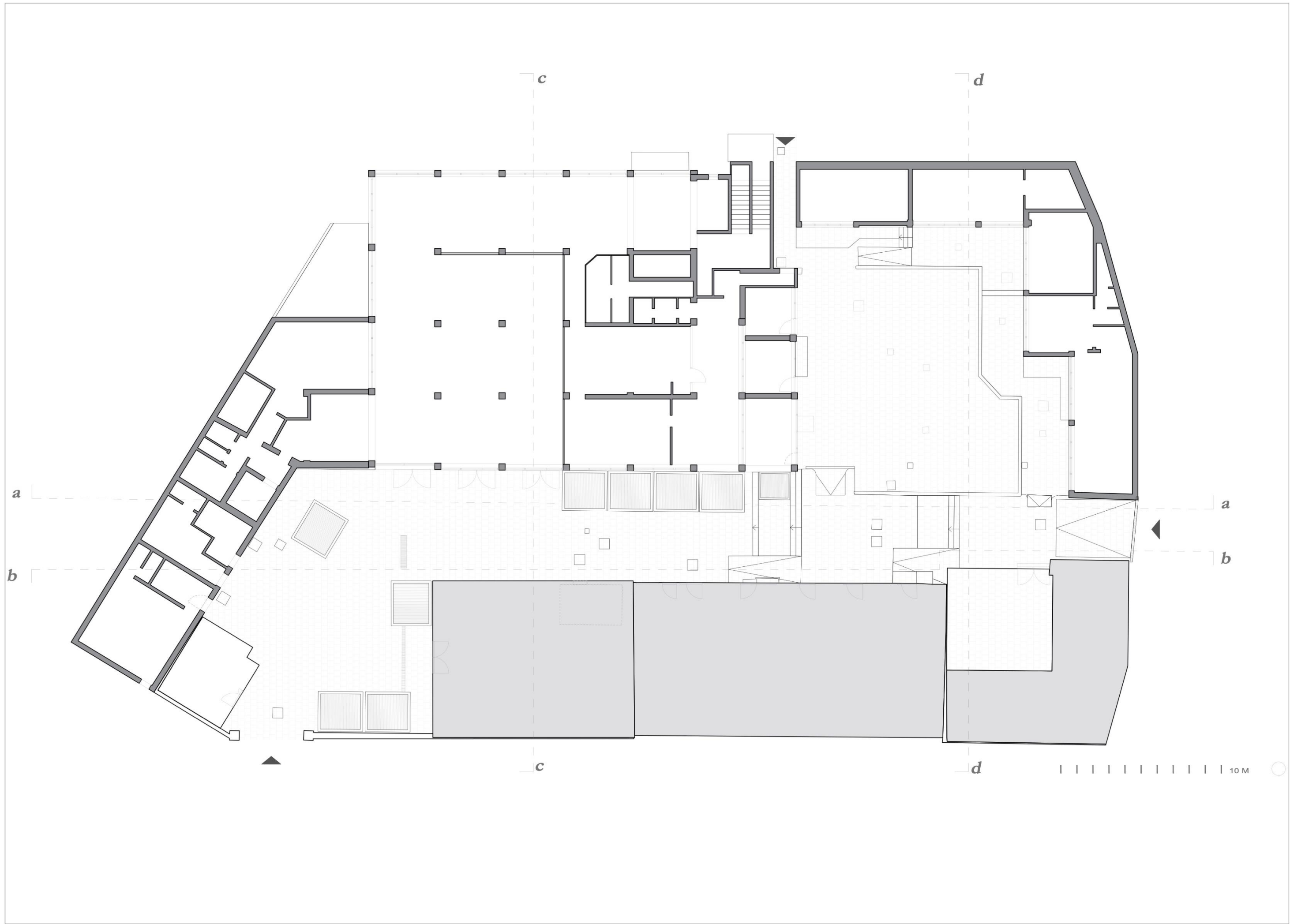

tlocrt - prizemlje

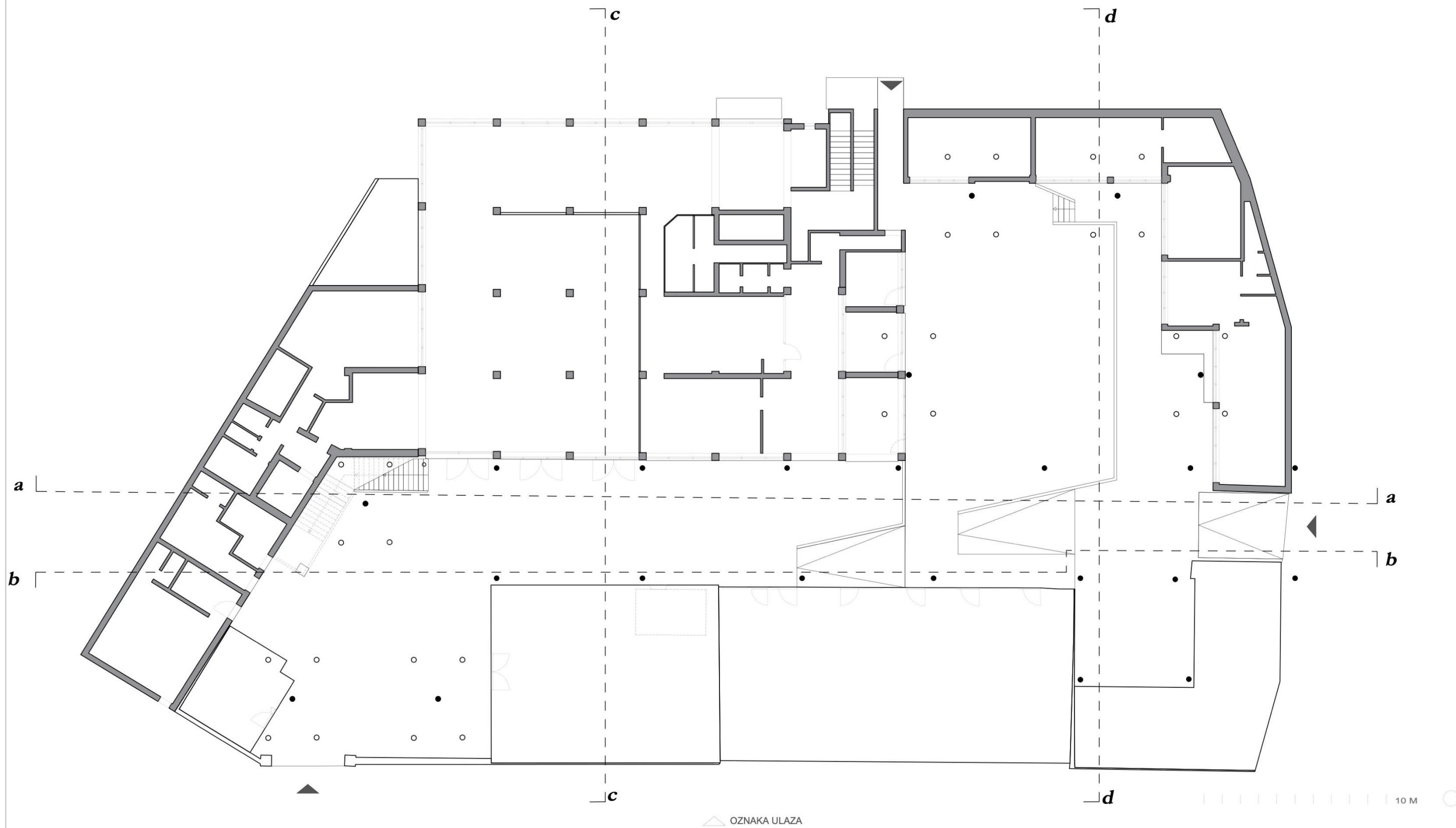

tloušť - kote

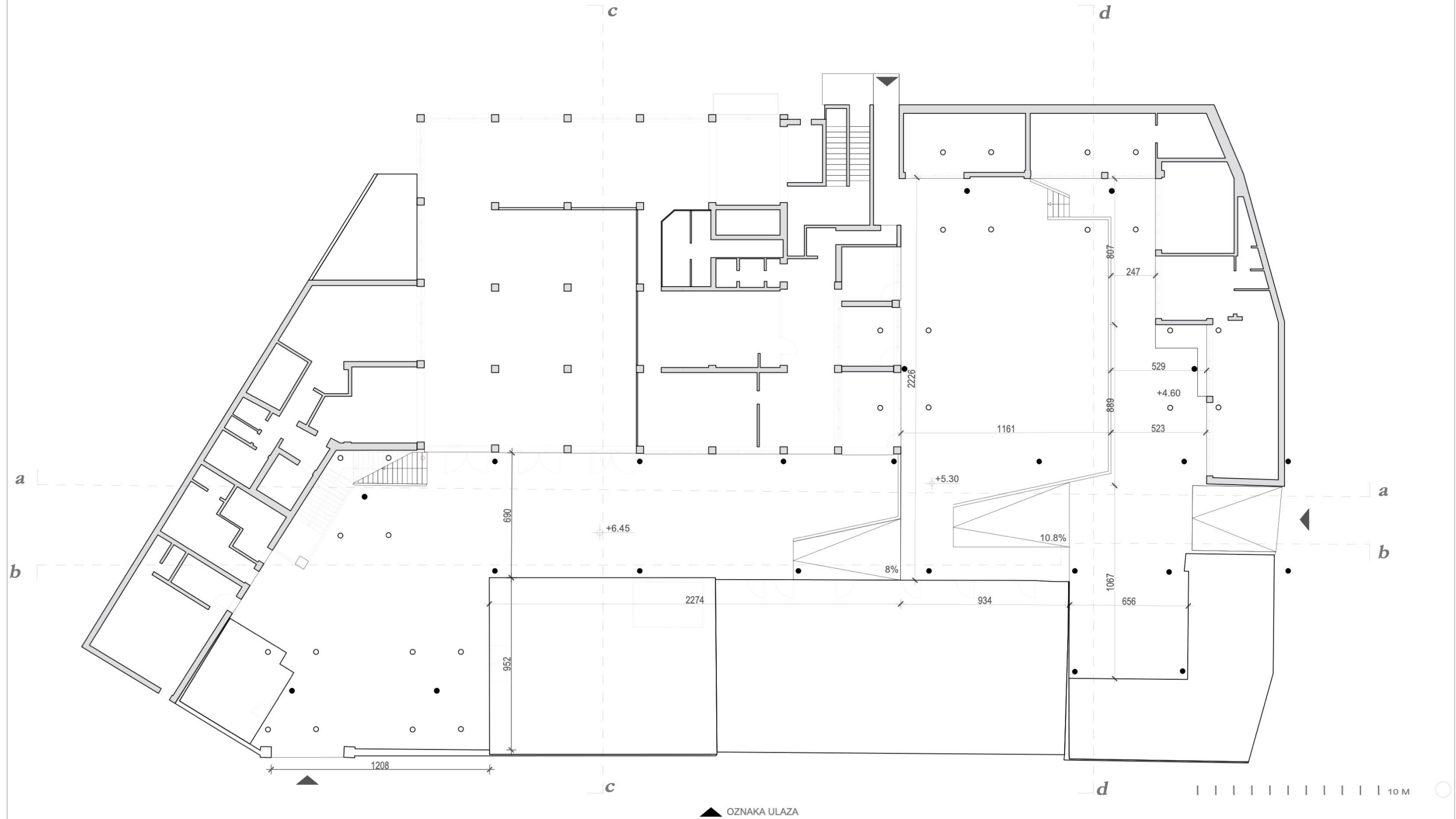

OZNAKA ULAZA



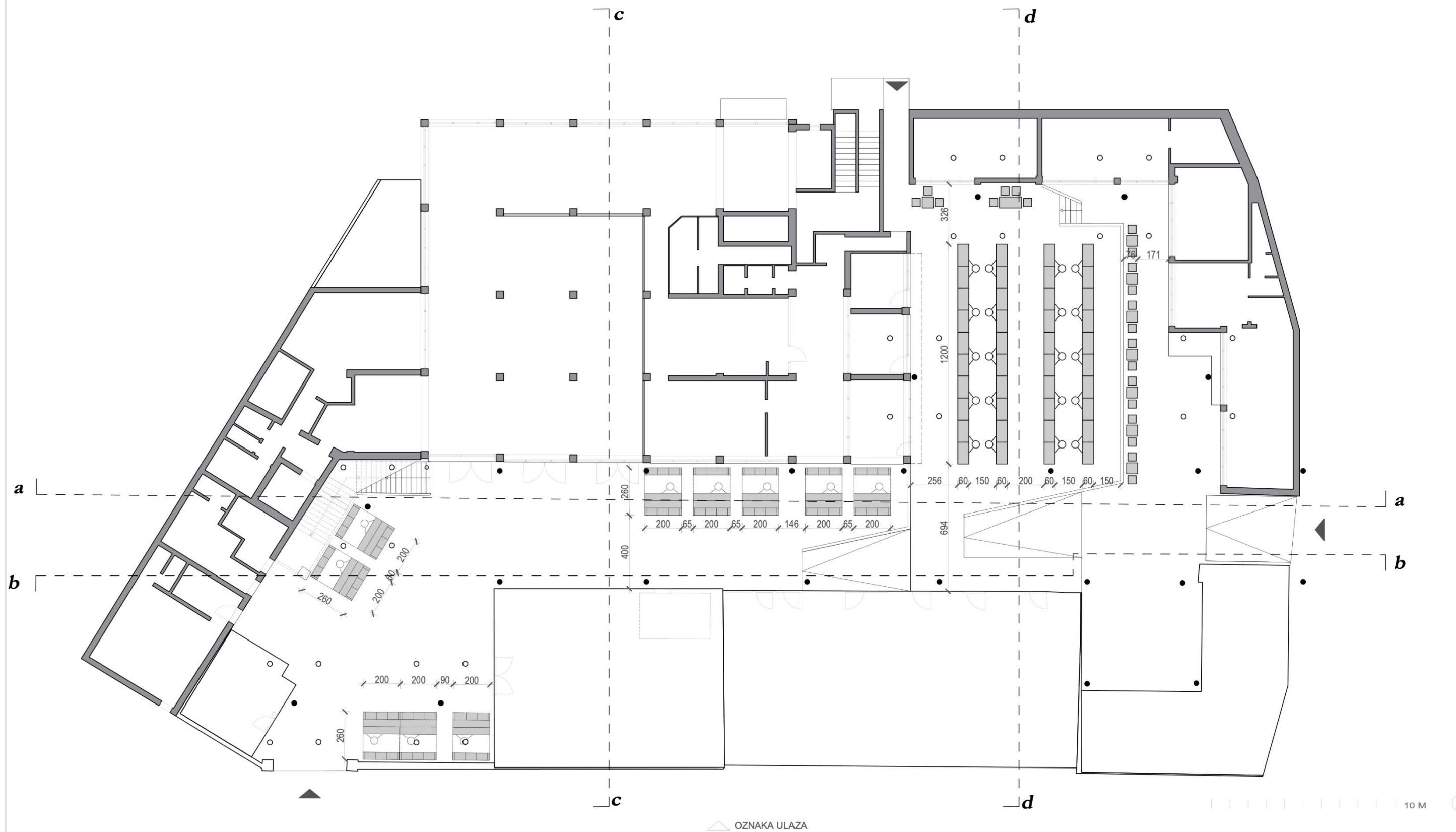

TLOCRT PARTERA TRŽNICE - OPLOČENJE

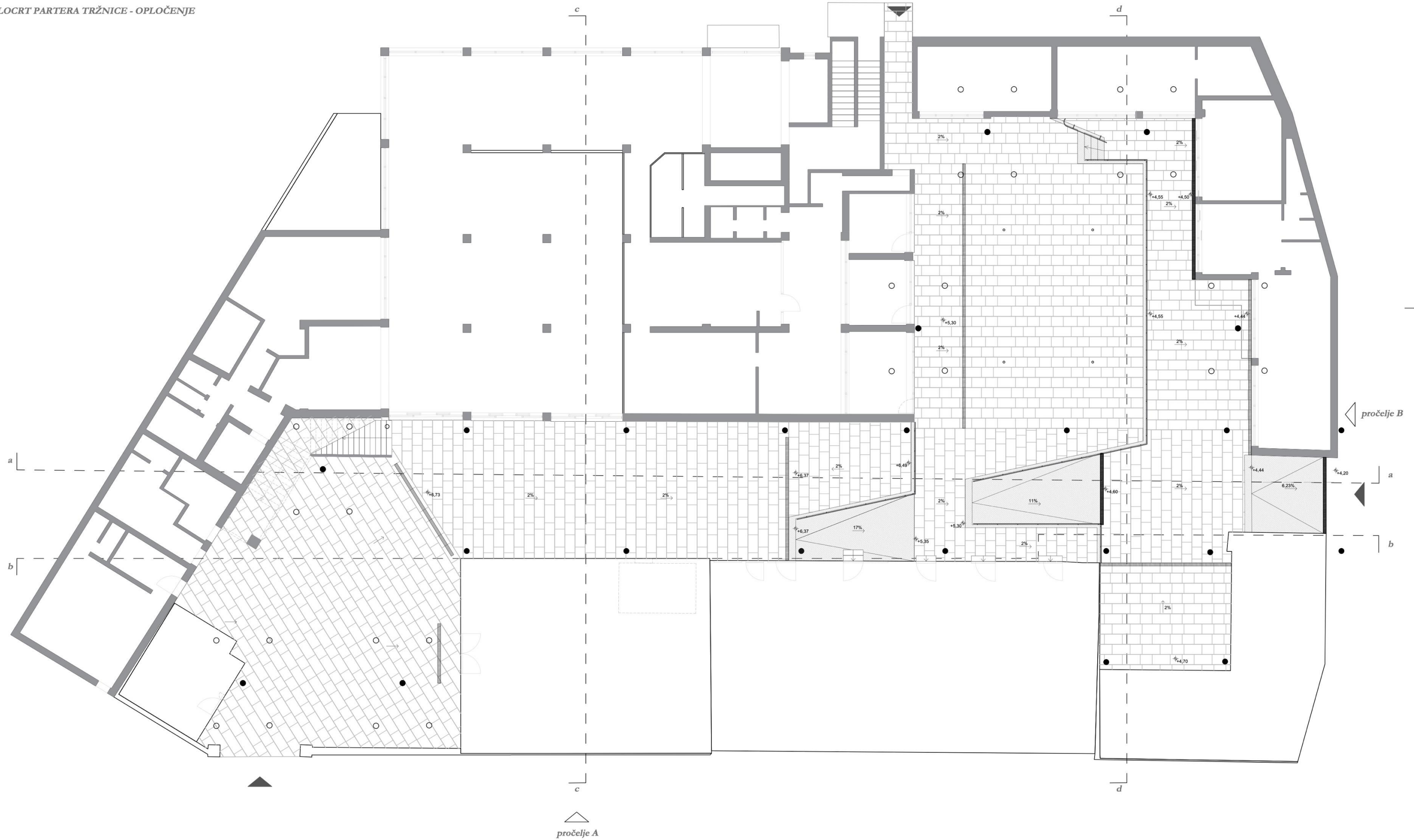

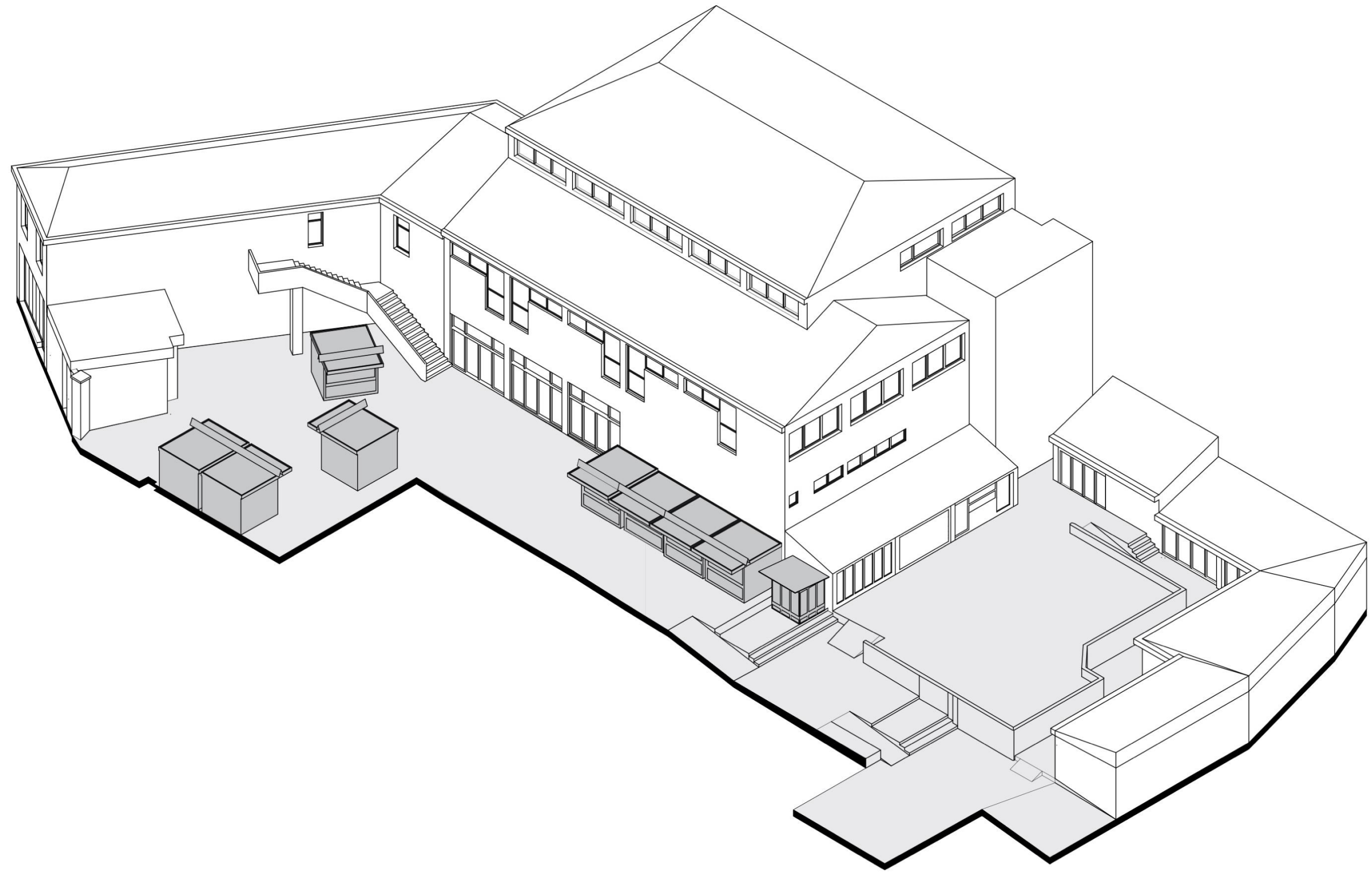



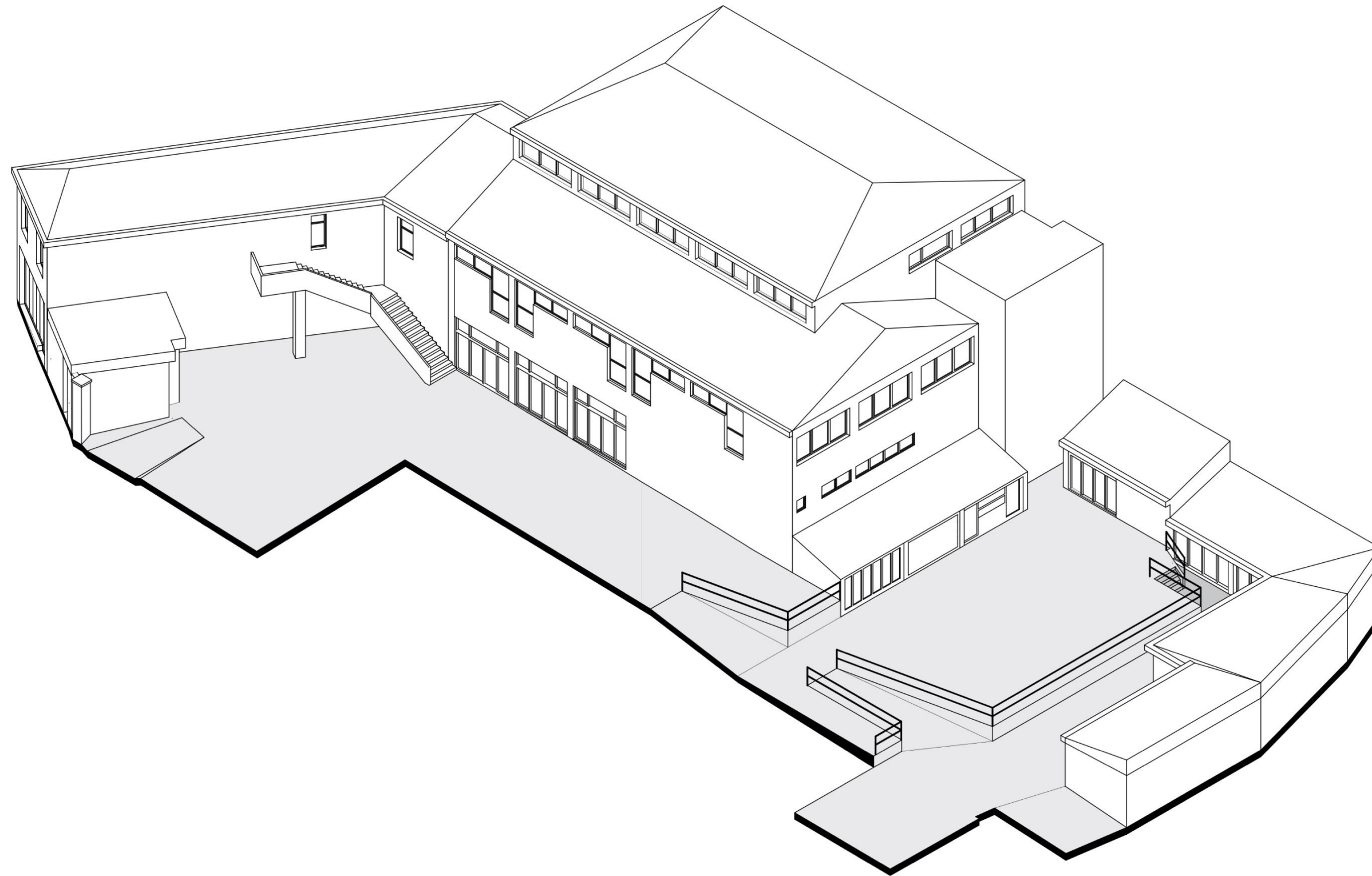

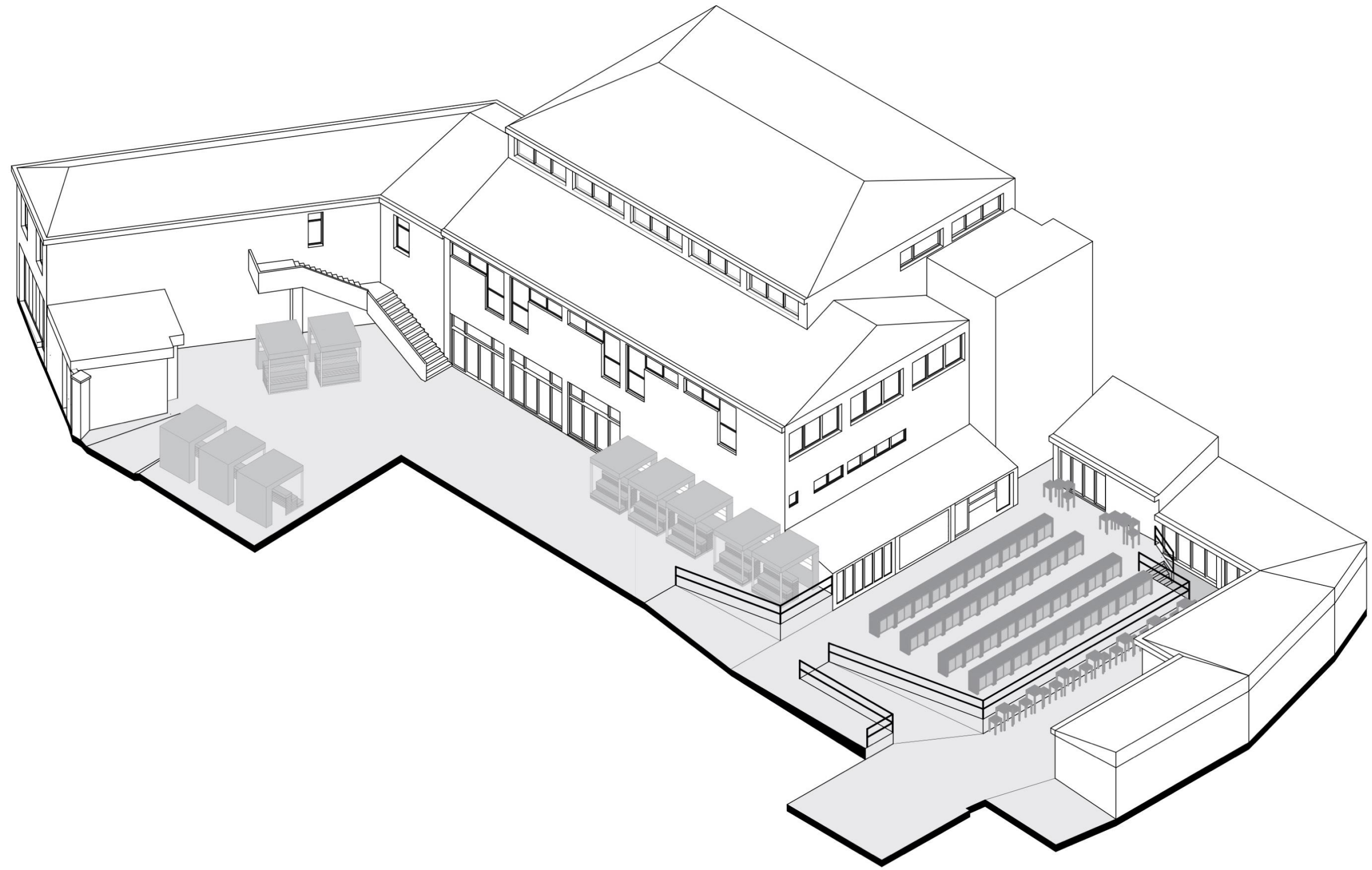

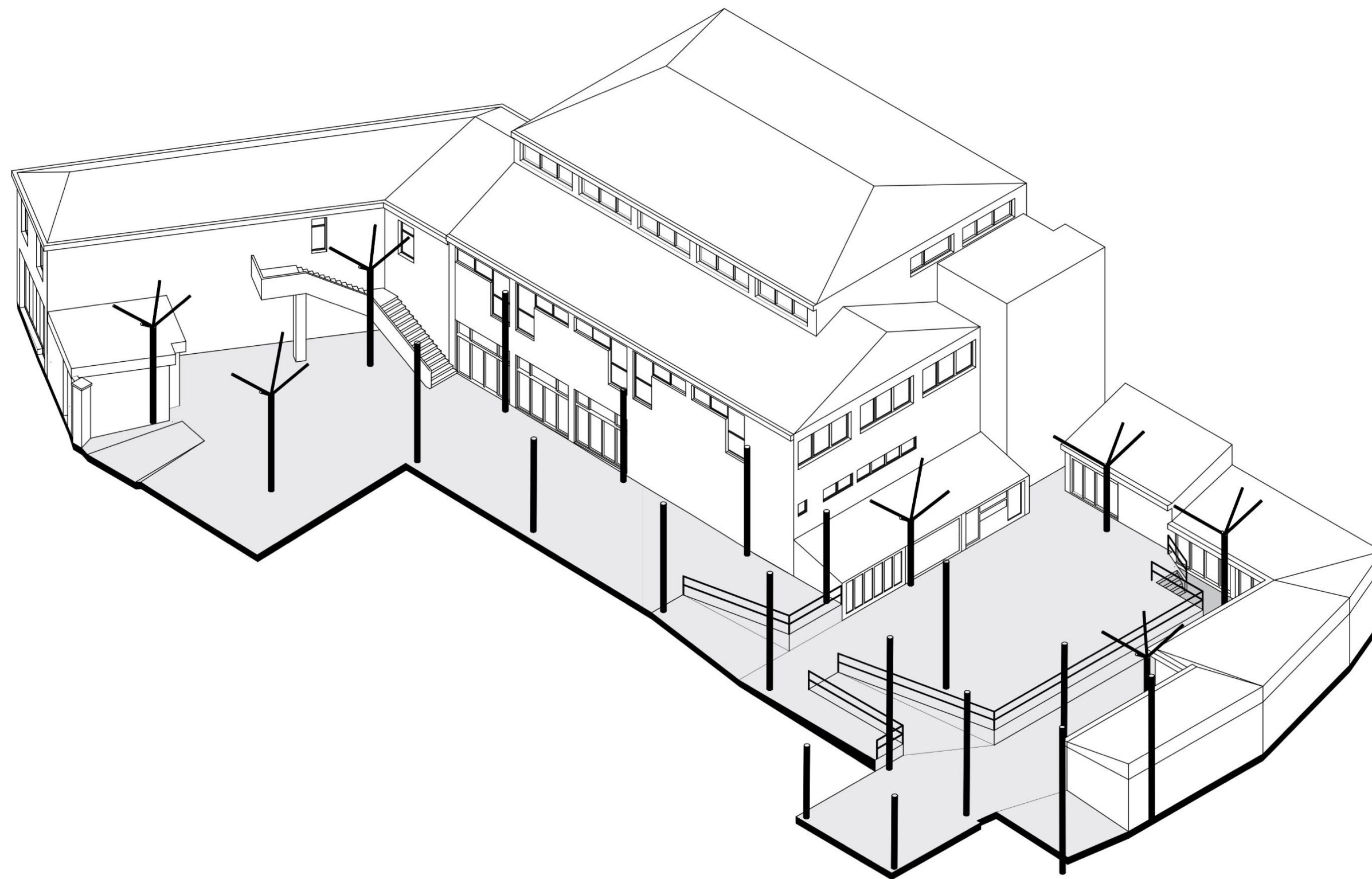

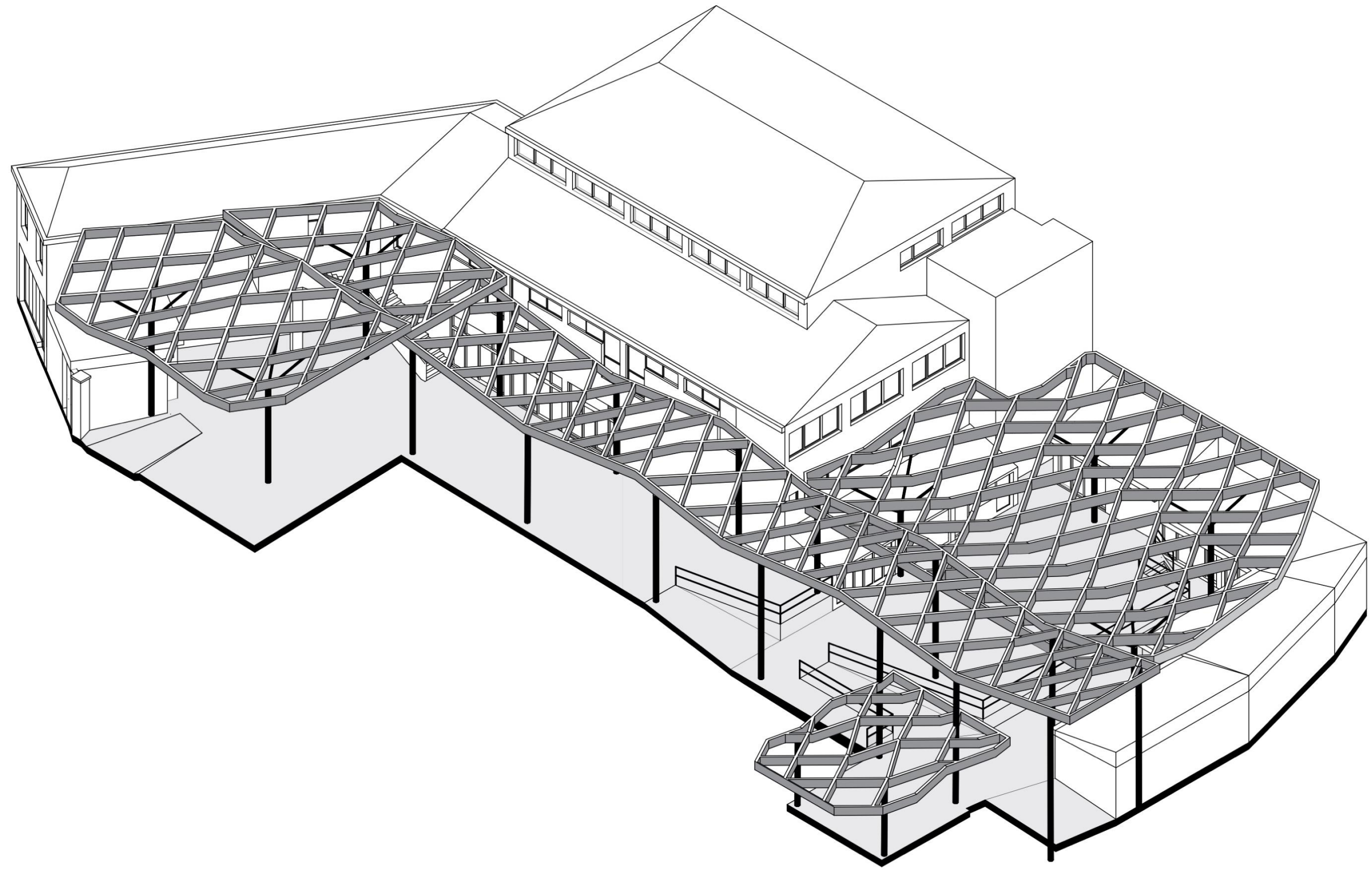

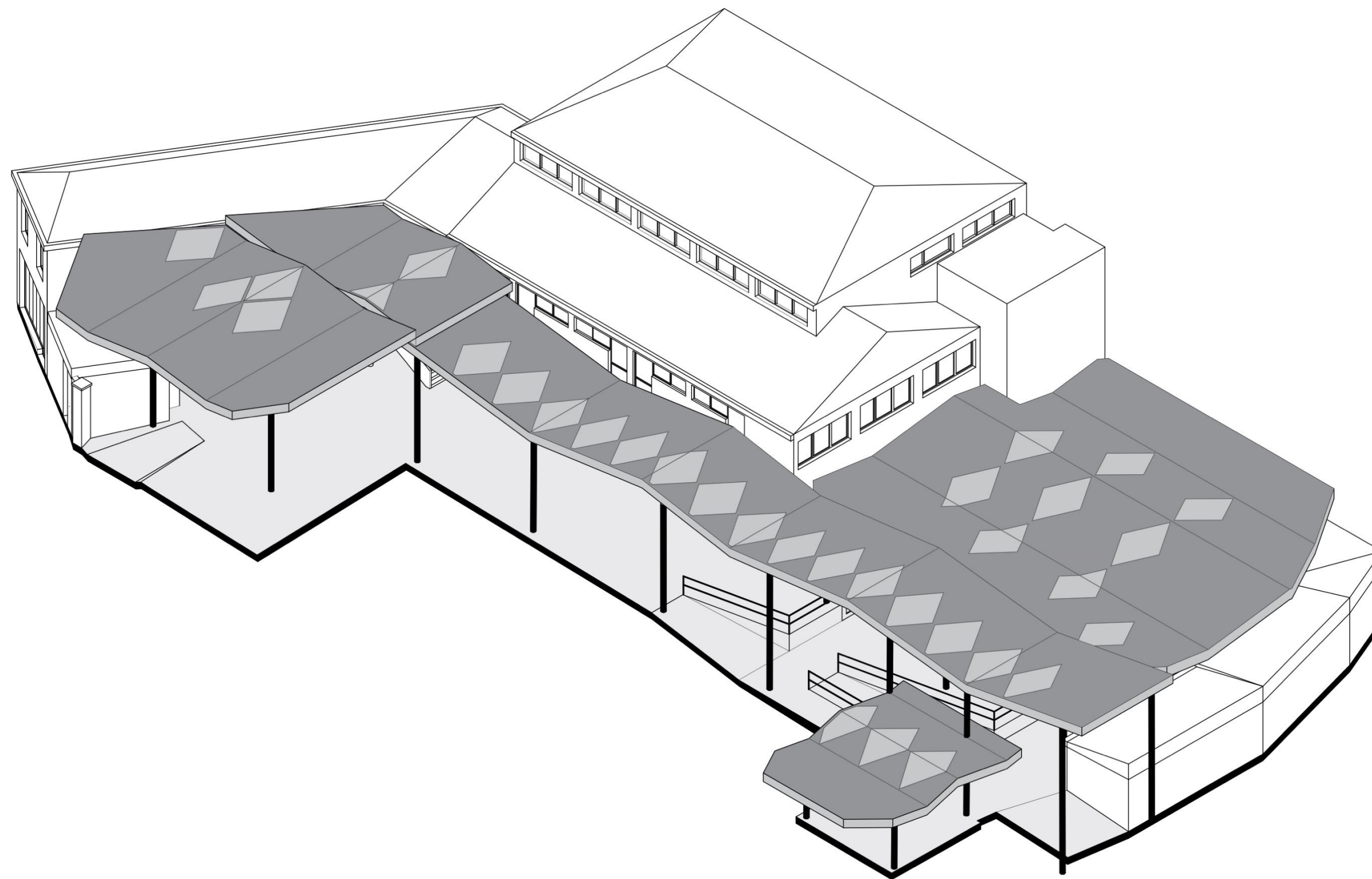

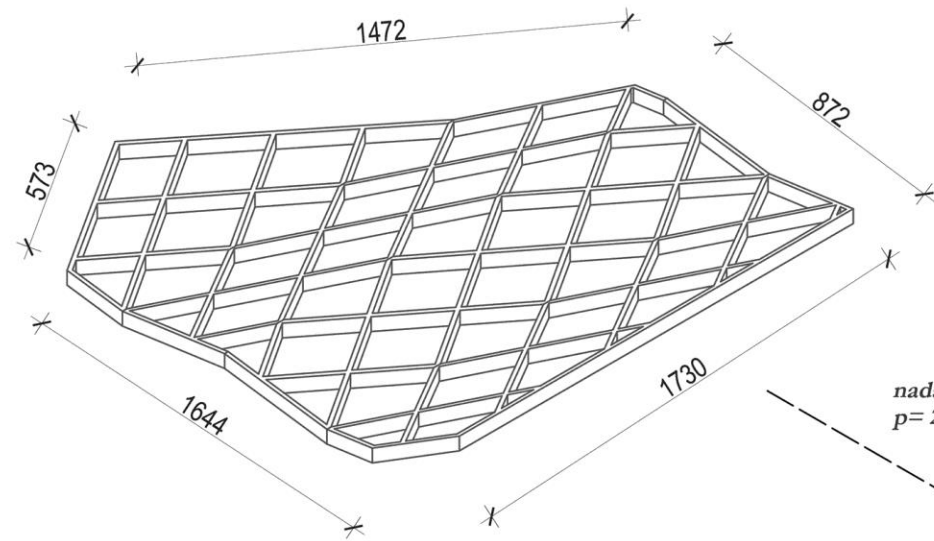

nadstrešnica D  
p= 226,70 m<sup>2</sup>

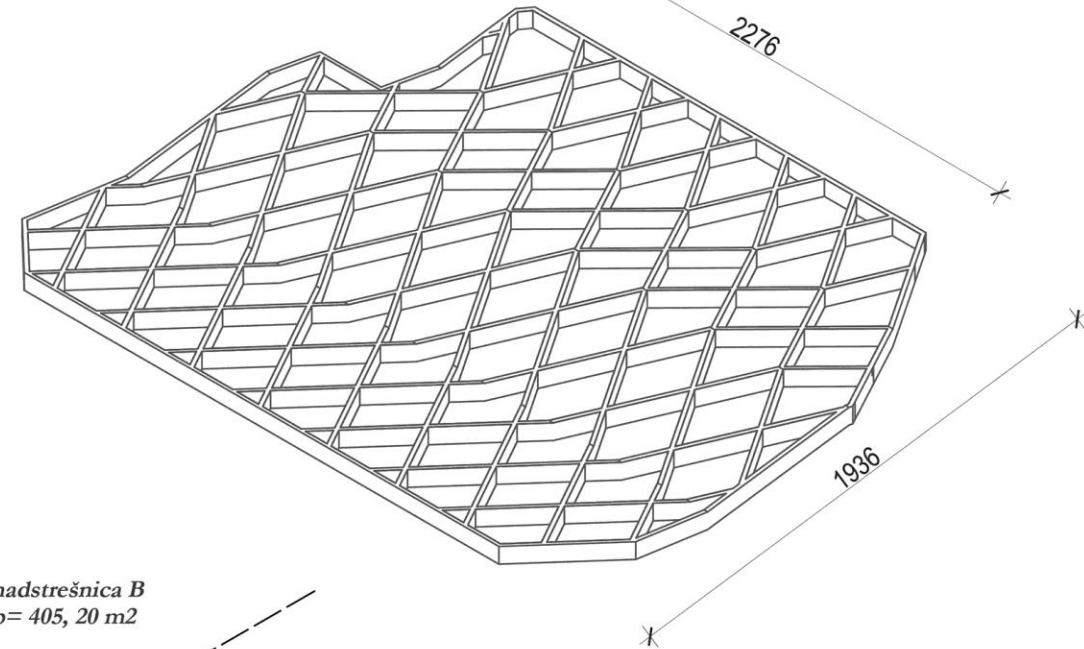

nadstrešnica B  
p= 405,20 m<sup>2</sup>

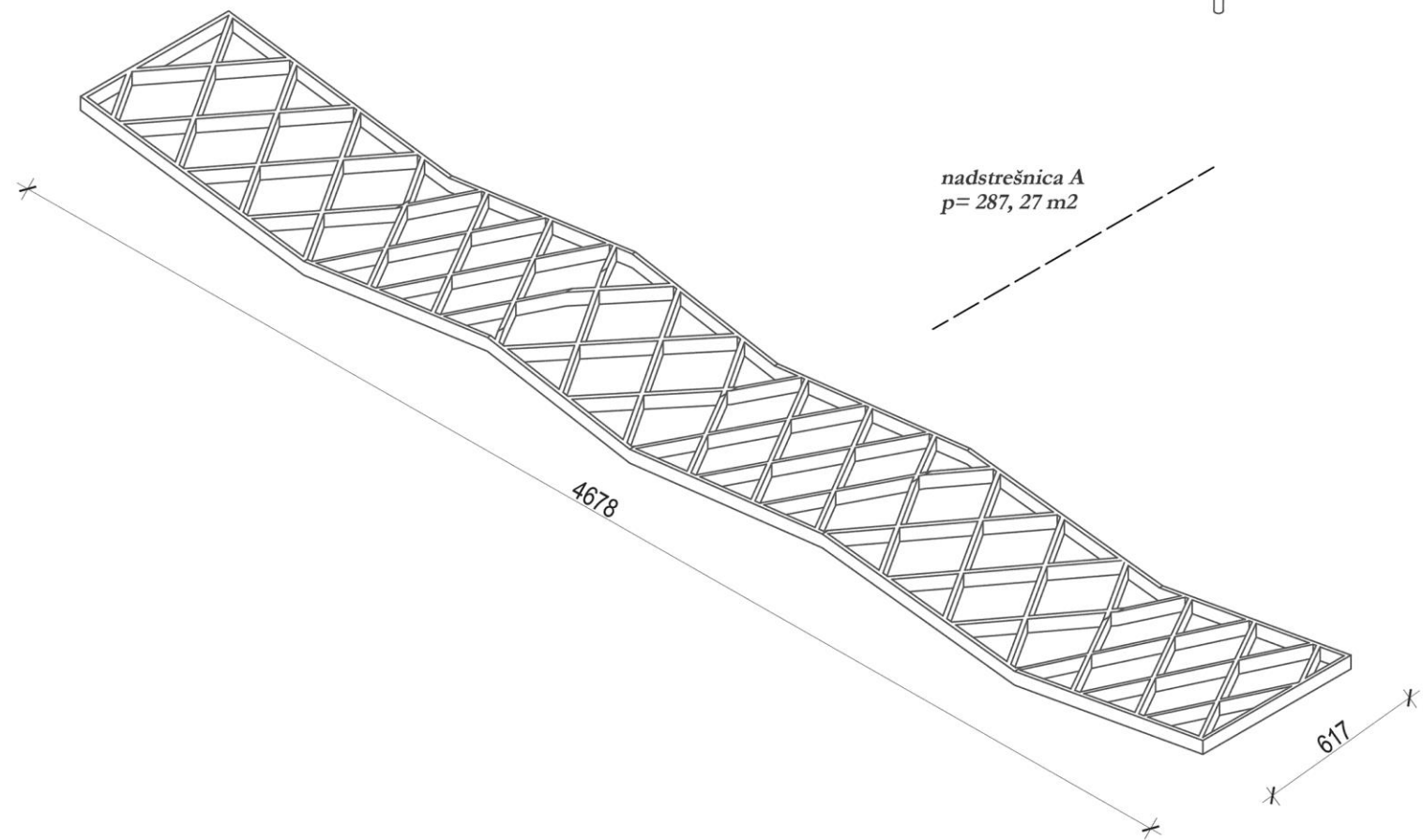
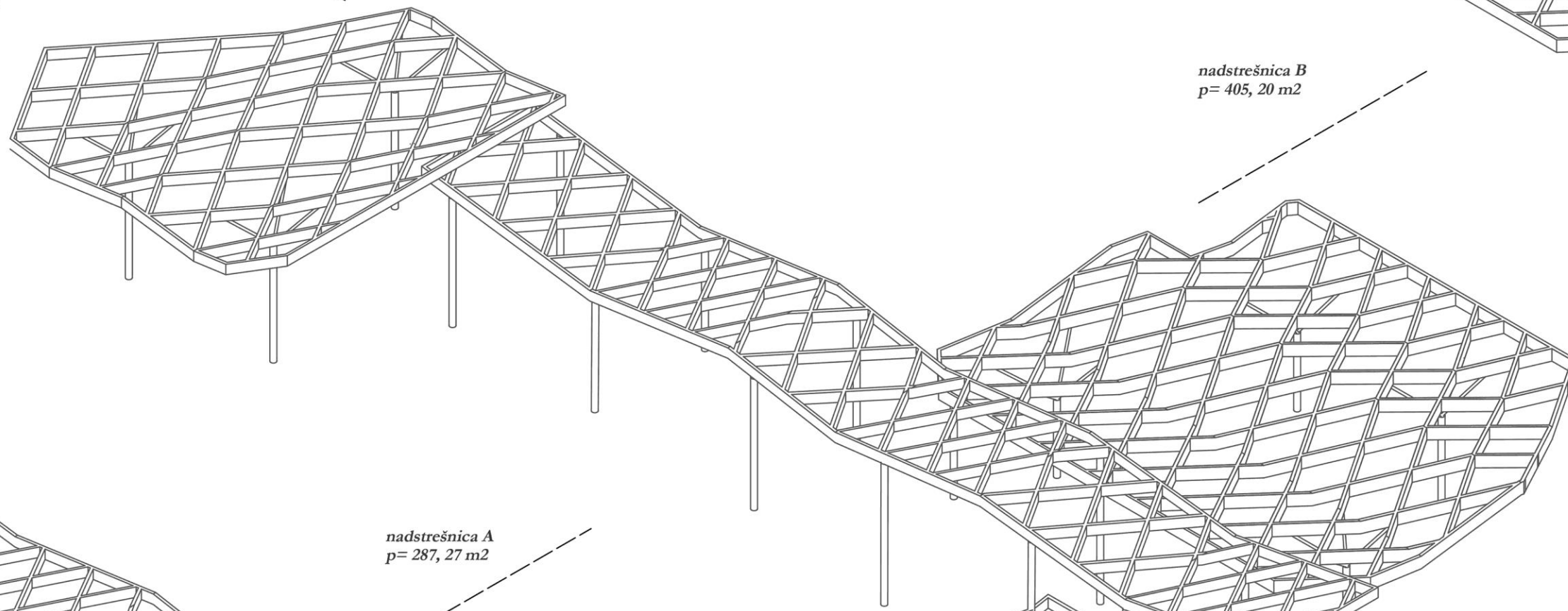

nadstrešnica A  
p= 84,50 m<sup>2</sup>

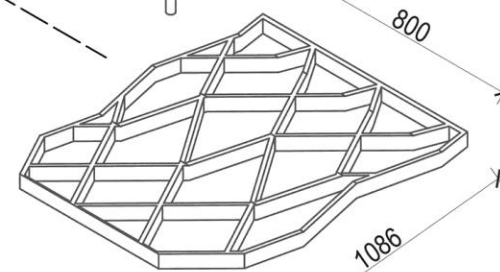

**PRESJEK A-A**



**PRESJEK B-B**



# PROČELJE A



# PROČELJE B

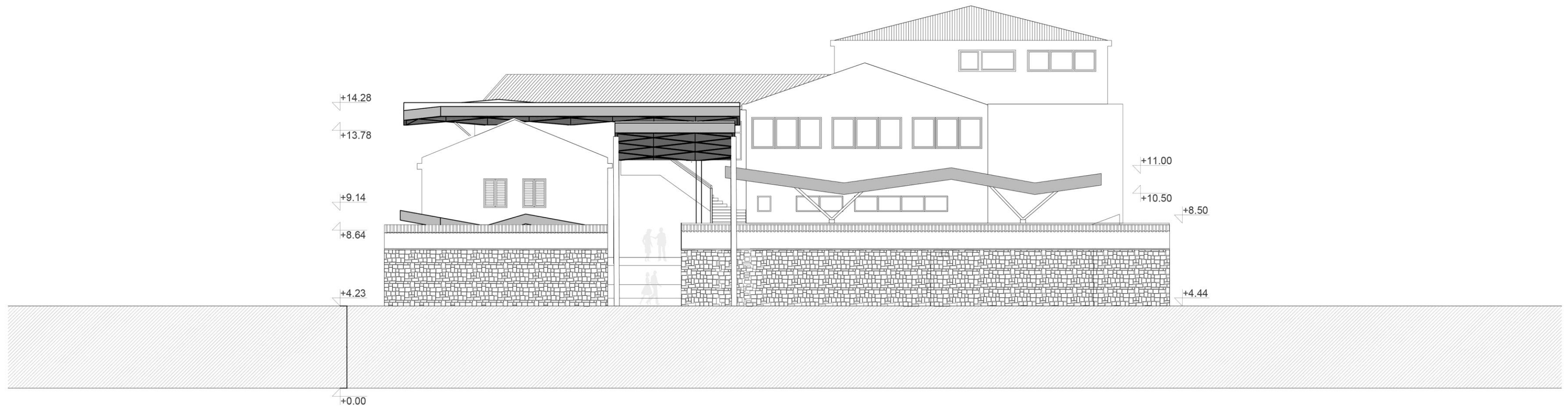







City ←  
0,3 m

AGRARIA - ŽELJEZARIJA  
RITOŠA  
trgovina d.o.o.  
← 30m 052 453 580  
052 431 321

← dm

P  
↻

↻  
Osim  
vozila opskrbe  
0 - 24 h  
Vrijeme ostajanja  
max. 30 min.























SERVING GOOD  
GOD